

Neenah R-4999-KX Bolted

Series

R-4999-KX

Cut Sheet

33" Wide Bolted Assy

33" Wide NEENAH Bolted Heavy Duty Trench Drain Grate and Frame Assy

Product ID: R-4999-KX

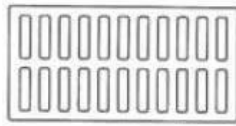
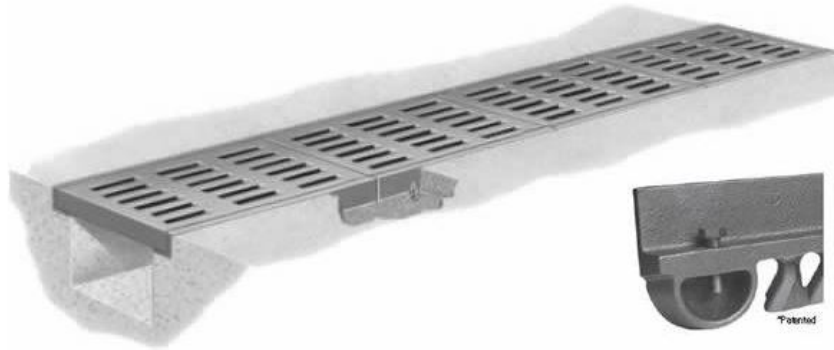

TYPE A
GRATE OPENINGS

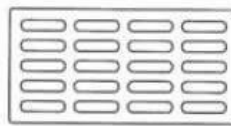

TYPE C
GRATE OPENINGS

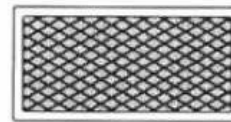

TYPE D
SOLID LID

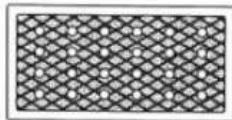

TYPE E
VENTED LID

33" Wide Bolted Neenah R-4999-KX Series Trench Grate

33"W X 24"L X 2"D

Choose Type A,C,D,E

Illustrating Type C bolted trench. Bolted trench sections are furnished in 24" standard lengths. When bolted trench is furnished, they are shipped assembled – AT NO TIME should the units be disassembled during installation. When removing covers, do not mix or rotate 180 degrees as bolt holes may lose alignment and improper bearing may occur.

Note: In Type A and P grates the slots are perpendicular to the trench run. In Type C and Q grates the slots are parallel with the trench run.



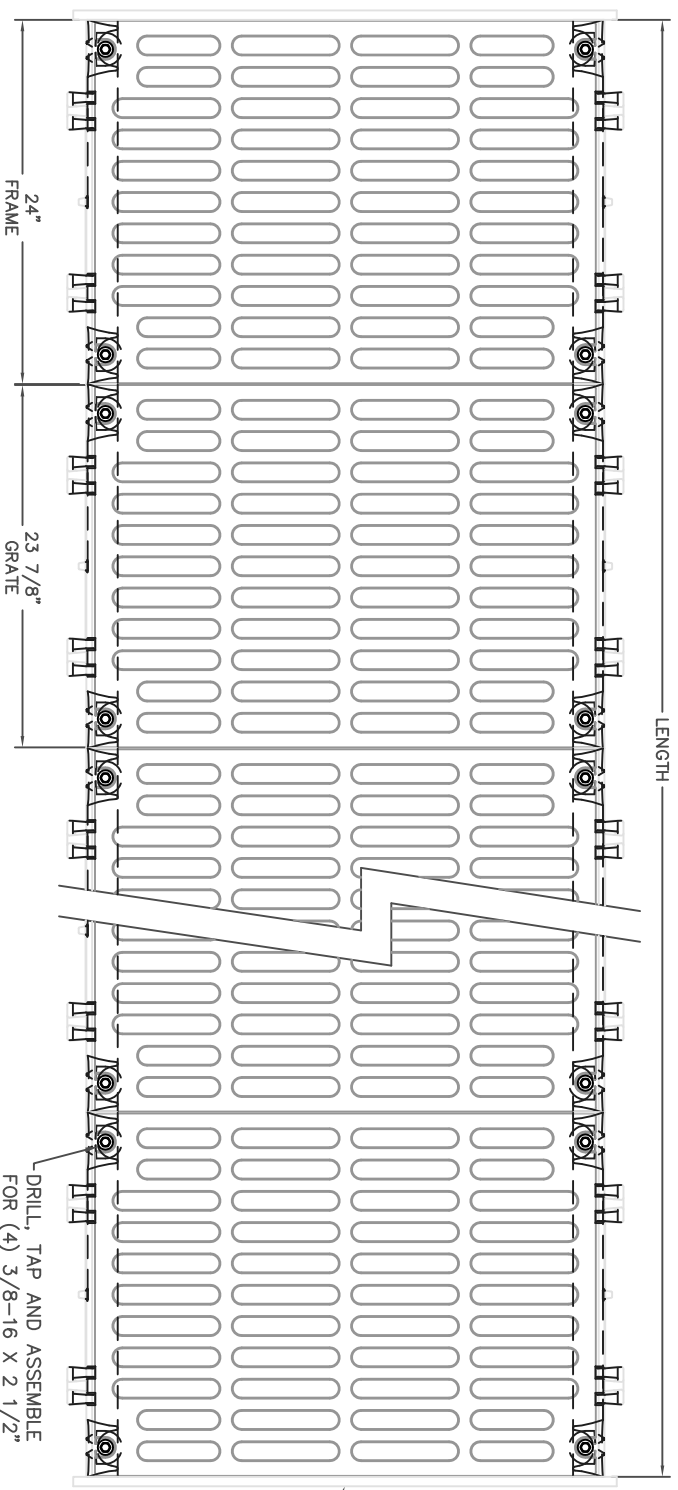

DRILL, TAP AND ASSEMBLE FOR (4) 3/8-16 X 2 1/2" STNLS, STL, HEX HD. SCREWS AND WASHERS. (KIT NO. 91370)

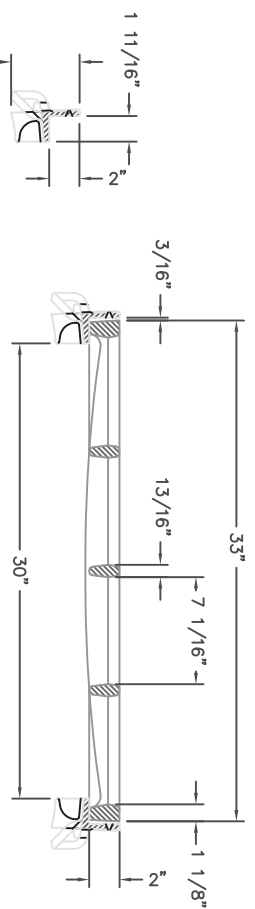

SECTION VIEW TYPE "A" GRATE
 TYPE "B" FRAME
 4999-KX

CAD DWG. REF: 4999KA.ADWG- 2

DR.	RKB	SCALE	TITLE:
CH.	XXX	1/8"=1"	TYPE "B" FRAME w/ TYPE 'A' GRATE
APP.	XXX		R-4990-KX

DATE	CORRECTED TITLE BLOCK	REVISION	DR	CH	APP
10/17/2014			DR	CH	APP

NEENAH FOUNDRY		NEENAH WISCONSIN 54956	
NEENAH FOUNDRY		PHONE: 800-556-8073	
NEENAH FOUNDRY		LINCOLN, NEBRASKA 68529	
NEENAH FOUNDRY		PHONE: 800-234-7485	

NF-4999KX A B

R-4999

HEAVY DUTY BOLTED TRENCH WITH DEBRIS CHUTE

Materials: All frames and grates/lids are furnished standard in gray iron, meeting ASTM A48 Class 35-B for heavy-duty use. For extra heavy-duty use or superior durability requirements, see our ductile iron Airport and Port Grating Series on pages 286.

Neenah recommends project designers avoid the use of light duty trench installations because it is likely that applications will be subjected to heavy delivery vehicle traffic at some time. Furthermore, the use of a site could be changed to heavy duty use patterns at some unanticipated future date.

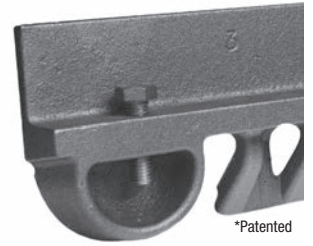

*Patented

Dimensions in inches

Bolted Catalog No.	A	B	C	Type A	Type C	Type D	Type E	Type P	Type Q
R-4999-AX	8	1 1/2	6	x	x	x	x	x	
R-4999-BX	10	1 1/2	8	x	x	x	x	x	
R-4999-CX	12	1 1/2	10	x	x	x	x	x	x
R-4999-DX	14	1 1/2	12	x	x	x	x	x	x
R-4999-EX	17	1 1/2	15	x	x	x	x	x	
R-4999-FX	20	1 1/2	18	x	x	x	x	x	
R-4999-GX	23	1 1/2	21	x	x*	x			
R-4999-HX	26	1 1/2	24	x	x*	x	x		x
R-4999-JX	30	2	27	x	x	x			
R-4999-KX	33	2	30	x	x	x*	x		
R-4999-LX	36	2	33	x	x	x*			
R-4999-MX	39	2	36	x	x*	x			
R-4999-NX	45	2	42	x	x*	x			
R-4999-OX	51	2	48	x		x*			

x - Indicates availability.

* Deep Ribs (consult shop drawing for dimensions).
Deep Ribs = "B" dimension times 2 or greater.

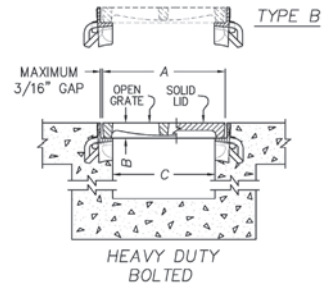

General schematic shown may not apply to all designs. Bar and rib depths, plate thicknesses, and seating widths vary on different sizes and styles. If your project has design restrictions, contact your sales representative or product engineering.

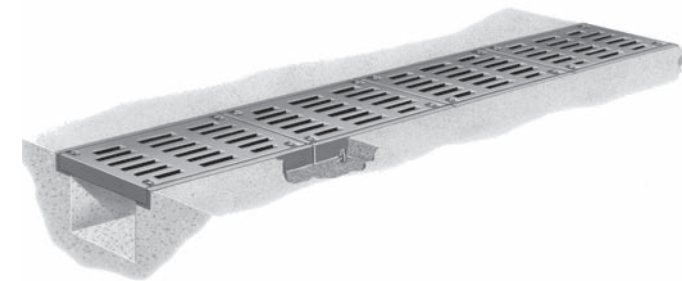

Illustrating Type C bolted trench. Bolted trench sections are furnished in 24" standard lengths. When bolted trench is furnished, they are shipped assembled – AT NO TIME should the units be disassembled during installation. When removing covers, do not mix or rotate 180 degrees as bolt holes may lose alignment and improper bearing may occur.

Note: In Type A and P grates the slots are perpendicular to the trench run. In Type C and Q grates the slots are parallel to the trench run.

Read Carefully Before Ordering

The various standard trench drains are available with a number of alternatives. It is important to examine all of the variables carefully and specify your requirements fully. Your order will be entered correctly and promptly if it includes the following information:

- Complete catalog number
- Frame end pieces, when required
- Type of Lid or Grate: A, C, D, E, P or Q
- Length of trench sections
- Angles and intersections *
- Load requirements

*Trenches with angles, intersections, size changes or other special requirements require detail drawings prior to ordering. Contact your sales representative or product engineering for assistance.

800-558-5075

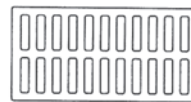

TYPE A
GRATE OPENINGS

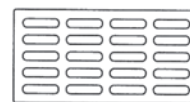

TYPE C
GRATE OPENINGS

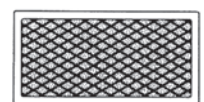

TYPE D
SOLID LID

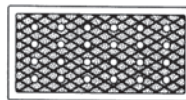

TYPE E
VENTED LID

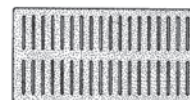

TYPE P
GRATE OPENINGS

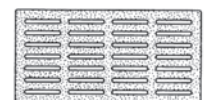

TYPE Q
GRATE OPENINGS

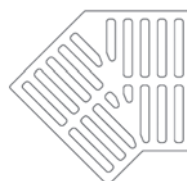

TYPE A
45 DEGREE
INTERSECTION PC.

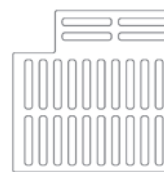

TYPE A
90 DEGREE
INTERSECTION PC.

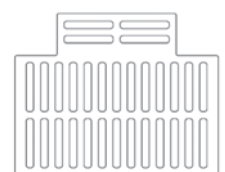

TYPE A
"T" INTERSECTION PC.

Note: 45°, 90° and "T" available in limited sizes and types.

Suggested Forming Instructions for R-4999 Frame and Grate/Lid

Bolted Units

Bolted frames and grates are furnished assembled and, therefore, require different forming procedures from unbolted units. Do check that the 3/16" maximum gap has not changed in transport. Details and suggestions are based on the Neenah Foundry Type B Frame.

Forming Procedures

Pour the floor slab of the trench according to the plans and specifications. The width of the forming, (see Figure 1) measured from the outside edges of the forms, corresponds to the "C" dimension on Figure 2. During the entire forming procedure, verify that the forms are plumb, straight, solid and level.

The rebar shown in the vertical walls of the trench is for illustrative purposes only. Proper sizing and placement is the responsibility of the engineering firm providing the project design.

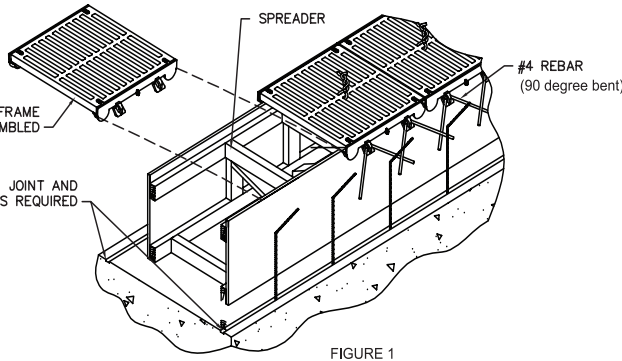
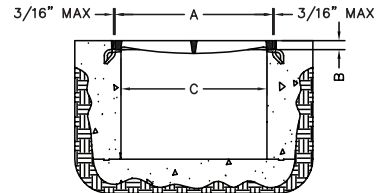

FIGURE 1



PARTIAL SECTION VIEW OF COMPLETED TRENCH INSTALLATION

FIGURE 2

When installing the frame and grate units on the forms (see figure 3). Keep the sections tight to one another to eliminate creep. When the sections are in the proper position, wire them to the bracing as show in Figure 4. Place a #4 rebar bent at 90° through the holes in the anchor lugs to provide proper anchorage in the concrete.

When concrete is cured, remove the grates, marking their position and orientation then strip the forms. Replace the grates/lids in the same location and with the same orientation as they came out. Bolts should be tightened to 15 foot-pounds. The completed installation should resemble figure 5.

General Comments

All frame sections are manufactured and furnished in standard 24" lengths. It is the responsibility of the installer to cut frame pieces to the proper length and miter corners where applicable. In cases where trench direction must change, special drawings will be furnished by our engineering services department. These prints will show special lengths and cuts of grates/lids and other essential information.

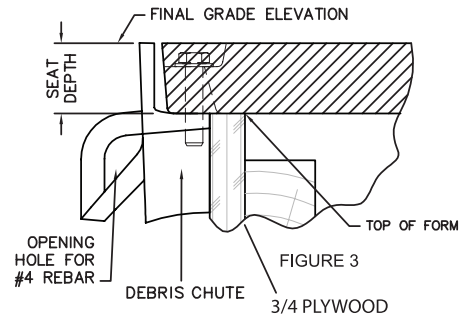

FIGURE 3

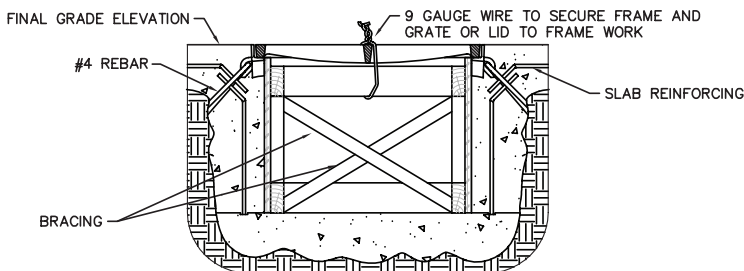

FIGURE 4

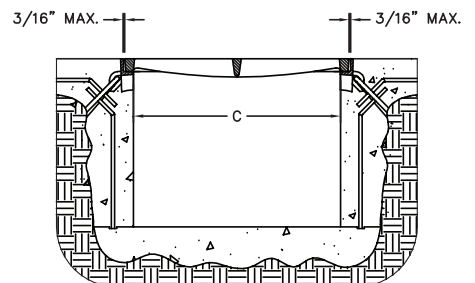

FIGURE 5

Supplied By:



877-903-7246

www.trenchdrainsupply.com